

# System 34000

## *ADVANCED FIRE DETECTION AND ALARM SYSTEM*

Operating Manual  
Issue 1  
October 1998

Gent Limited  
International office  
140 Waterside Road  
Hamilton Industrial Park  
Leicester, LE5 1TN  
United Kingdom  
Tel: +44 (0)116 2462200  
Telex: 342367 GENT G  
Fax: +44(0)116 2462018

User responsibility

Control and indicating  
equipment

Quick reference

Emergency  
conditions

Other controls

Site labels

Log book sheets

Index

Parts list

## Preface

This first issue covers instructions for operating the equipment in both standalone and network systems.

There are step by step instructions on what to do in an emergency and when operating other controls.

## Associated Documents

13563-011            GENT Supervisor Operating Manual

34K\_MAN\_INS        Installation Manual for System 34000

## Conventions

**NOTE** : A note highlight important text that is normally hidden in the main text.

**CAUTION** : A caution is given to prevent damage to equipment.

**WARNING** : A warning is given to advise of dangerous conditions that may result in injury or death.

Issue Record			
Section	Issue	Date	Comments
Prelims	1	10/98	This is the first issue of the Operating Manual for System 34000
1 - 7	1	10/98	
Index	1	10/98	
Parts	1	10/98	
Phone			

The information contained herein is the property of GENT LIMITED and is supplied without liability for errors or omissions. No part of the manual may be reproduced in any form soever without prior consent of the company. Due to the on going development of GENT System 34000 the information contained in the manual is subject to change without notice.

## Customer feedback

If you have any comments on this manual, then please provide them below.

Post completed sheet to the address overleaf or pass on to your area sales representative.

Thanks

Your name: \_\_\_\_\_

Address: \_\_\_\_\_

\_\_\_\_\_

\_\_\_\_\_

Manual number and title \_\_\_\_\_

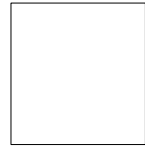

Technical Publications  
Gent Limited  
Waterside Road  
Leicester  
LE5 1TN  
United Kingdom

---

# Table of Contents

User Responsibility . . . . .	1-1
Daily . . . . .	1-1
Weekly . . . . .	1-1
Quarterly . . . . .	1-2
Battery Replacement . . . . .	1-2
Panel Battery . . . . .	1-2
Memory Card Battery . . . . .	1-2
Manual Call Point . . . . .	1-2
Testing a Manual Call Point . . . . .	1-2
Replacing a broken Glass . . . . .	1-3
Installing the Printer Paper . . . . .	1-4
Printer Operation . . . . .	1-4
Control and indicating equipment . . . . .	2-1
Visual and audible Indications . . . . .	2-1
Normal Condition . . . . .	2-2
Quick Reference . . . . .	3-1
First level controls . . . . .	3-1
Quick Reference Guide . . . . .	3-2
Emergency Conditions . . . . .	4-1
How to raise an ALARM of Fire . . . . .	4-1
In the event of a FIRE Condition . . . . .	4-2
To Silence Alarms . . . . .	4-2
To Reset the System . . . . .	4-2
Fire Indications . . . . .	4-3
In the event of a FAULT condition . . . . .	4-4
To Cancel the Fault Buzzer . . . . .	4-4
Fault Indications . . . . .	4-4
Action to Rectify a Fault Event . . . . .	4-5
In the event of a WARNING condition . . . . .	4-7
Warning Indications . . . . .	4-7
Action to Remove a Warning Event . . . . .	4-7

To sound all Fire Alarms globally . . . . .	4-9
To Sound Alarms . . . . .	4-9
To Silence Alarms . . . . .	4-9
To sound the Master Alarms . . . . .	4-10
To sound the Sector Alarms . . . . .	4-10
<b>Operating the MENU ON/OFF . . . . .</b>	<b>5-1</b>
Testing the display and indicators . . . . .	5-2
Testing the Mimic and Zonal panels . . . . .	5-2
Setting the System Clock . . . . .	5-4
Viewing the current Fire Log . . . . .	5-6
Viewing the current Fault Log . . . . .	5-7
Viewing the current Warning log . . . . .	5-8
Viewing the Historic Log . . . . .	5-9
Viewing Supervisory Active Events . . . . .	5-10
Viewing the Supervisory log . . . . .	5-12
Changing the UserCode Password . . . . .	5-14
Using the Printer . . . . .	5-15
Editing Label Information . . . . .	5-17
Viewing Labels . . . . .	5-19
Saving changes to the Memory Card . . . . .	5-21
Enabling or Disabling Parts of the System . . . . .	5-22
Switching the Auxiliary Relays . . . . .	5-26
Viewing Cards Information . . . . .	5-27
Viewing a Loop Map . . . . .	5-28
Viewing Network Map . . . . .	5-29
<b>Site Labels Information . . . . .</b>	<b>6-1</b>
Site Labels . . . . .	6-1
<b>Log Book Sheets . . . . .</b>	<b>7-1</b>
Logging Events . . . . .	7-1
Blank Log Sheets . . . . .	7-1
Completed Log Sheet . . . . .	7-1
<b>System 34000 system parts . . . . .</b>	<b>P-1</b>
Introduction . . . . .	P-1

---

Control and indicating equipment . . . . .	P-1
Sensors and Accessories . . . . .	P-2
Alarm sounders . . . . .	P-3
Manual call points (MCP) 2-way . . . . .	P-4
Interfaces . . . . .	P-4
Manuals & Accessories . . . . .	P-5
GENT Supervisor . . . . .	P-5
Converter / Compactor / UPS / Printer . . . . .	P-6

# Table of Figures

Figure 1-1 Replacing a broken MCP glass . . . . .	1-3
Figure 1-2 Loading the printer paper . . . . .	1-4
Figure 2-1 Control and indicating equipment . . . . .	2-1
Figure 2-2 Normal indications . . . . .	2-2
Figure 3-1 Controls accessible without opening door . . .	3-1
Figure 3-2 Control panel facia . . . . .	3-2
Figure 3-3 Quick Reference guide . . . . .	3-3
Figure 4-1 Fire indications and controls . . . . .	4-2
Figure 4-2 Fault indications and controls . . . . .	4-4
Figure 4-3 Warning Indications . . . . .	4-7
Figure 4-4 Sound alarms . . . . .	4-9
Figure 4-5 Silence Alarms . . . . .	4-9
Figure 5-1 Top level menu . . . . .	5-1
Figure 5-2 Lamp test on standard mimic panel . . . . .	5-2
Figure 5-3 Lamp test at A4 Mimic panel . . . . .	5-3
Figure 5-4 Set clock display . . . . .	5-4
Figure 5-5 Supervisory active . . . . .	5-10

# User Responsibility

It is recommended that the persons responsible for the fire alarm system should become familiar with the procedures on how to operate the controls and interpret indications given at specific products. Adequate training should also have been given from appointed personnel.

**British Standard** If your system is designed with a System 34000 Control panel that meets the requirements of BS 5839:Part 4:1988, then the use of [Disable] [IO Line] option under the [Control ] menu and [Set Clock] option under the [Setup] menu using the 'Customer Password' is not recommended.

## Daily

The British Standard code of practice for Fire detection and alarm systems for buildings, BS 5839:Part1:1988, states that the system should be inspected daily to ensure that a normal indication is given at the control and indicating equipment and that any previously indicated fault and warning condition has received appropriate attention.

- a) It recommends entry into the Log Book provided of all the system events for future reference. To view past events look at the Historic Events Log.
- b) The person inspecting the protected premises can ensure that the use of the area(s) inspected has not changed such that the detection and alarm devices have become inappropriate.
- c) The area(s) can be inspected to check that no unsafe practices that could lead to fire are being undertaken.

## Weekly

At Weekly intervals a different Fire Sensor or Manual Call Point of the system should be tested to ensure the system is capable of operating under alarm condition.

- a) The operation of the alarm sounders should be checked, which also provides a regular reminder to those occupying the premises that there is a fire alarm system with a particular characteristic sound.
- b) The test should be performed at a regular time to avoid confusion between a test and a genuine fire alarm.

## Quarterly

At quarterly intervals the system should be inspected and any work necessary should be performed by trained maintenance engineer. If you need help with any issues regarding maintenance, please contact your nearest Servicing organisation.

## Battery Replacement

***NOTE:** Any servicing work on the System 34000 system must be carried out by suitably qualified and trained engineers. If you need help with any servicing issues please contact Servicing organisation.*

### Panel Battery

Under normal operating conditions the maintenance free lead acid batteries located in the Control panel battery box, in the Repeat panel, in the Mimic and Zonal panels, A4 Mimic control unit and Mains powered interface unit can have a useful life of up to 5 years from the date of manufacture.

***NOTE:** It is recommended that these batteries are replaced at 4 Yearly interval from the date the System 34000 System is first commissioned.*

### Memory Card Battery

Under normal operating conditions the lithium battery on the Memory Card in the Control Panel can have a useful life of up to 10 Years from the date of manufacture.

***NOTE:** It is recommended that the Memory Card is replaced at 10 Yearly interval from the date the System 34000 system is commissioned.*

## Manual Call Point

### Testing a Manual Call Point

Push the test key through the hole in the underside of the call point to engage the test cam mechanism and push to operate the cam mechanism.

At this point the test key is retained in the call point and pulling it out will reset the glass.

***NOTE:** The appropriate sounders in the system will be activated by this test. To **silence alarms** and **reset** the system, see **Emergency controls** part of this manual.*

## Replacing a broken Glass

**WARNING:** Take appropriate precautions when clearing broken glass to prevent injury.

**NOTE:** A weather resistant version of manual call points will have two gaskets, a Cover/glass gasket and a Spacer/cover gasket, which must be installed in their respective position.

These procedures assume the cover on the manual call point is open and any broken glass has been cleared.

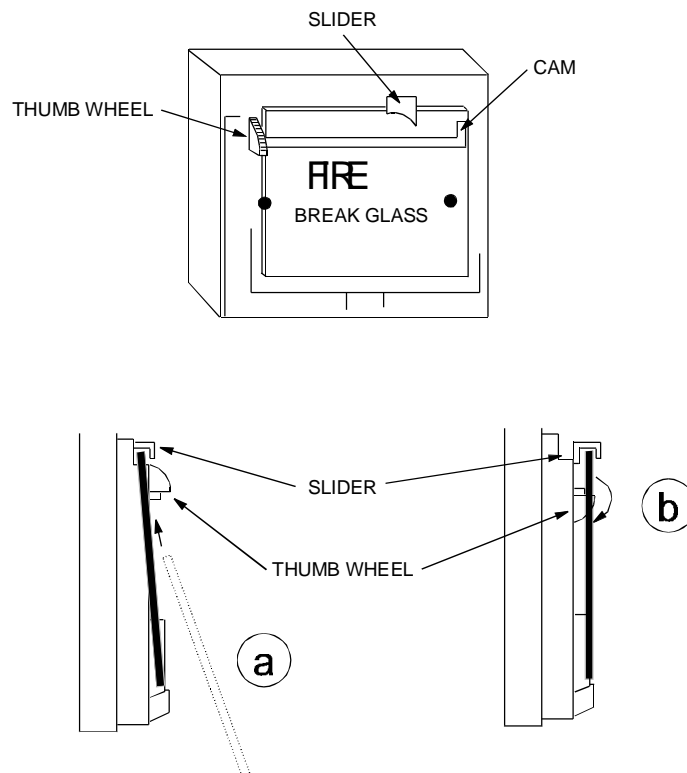

Figure 1-1 Replacing a broken MCP glass  
emf1216

- a) Feed the glass upward to push the cams down and fit under slider, locate bottom of glass into recess.
- b) Hold the bottom of glass in position and rotate the thumbwheel quadrant to raise the top of the glass.
- c) Fit the call point cover by hooking it into the top of the unit and making sure that the glass is properly seated (held down) tighten the cover fixing screw.

## Installing the Printer Paper

The printer paper roll is located on the inside of the inner door. A vertical line on the paper indicates end of paper. A new paper roll code number 34K-PAPER must be fitted.

- a) Open the control main door using the key supplied and inner door using the allen key supplied.
- b) Remove the old paper roll from inside of door assembly.
- c) Fit a new paper roll
- d) Insert paper into the printer mechanism.

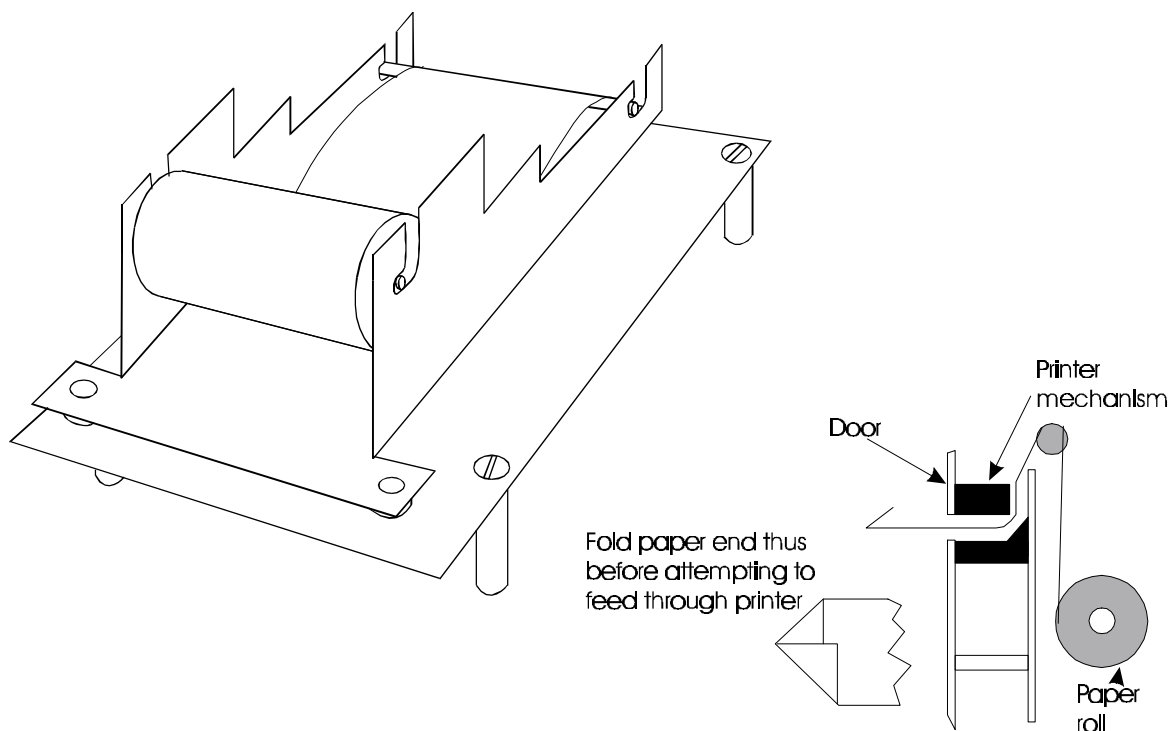

Figure 3-2 Loading the printer paper  
cdn304

- e) Turn the knob on the inner door downwards to feed the printer paper.
- g) Close the control panel door(s).
- f) Carry out a printer paper test, see section on using the printer in the others controls part of this manual.

## Printer Operation

The printer will operate if it is switched On and a printout is obtained upon occurrence of a system event.

# Control and indicating equipment

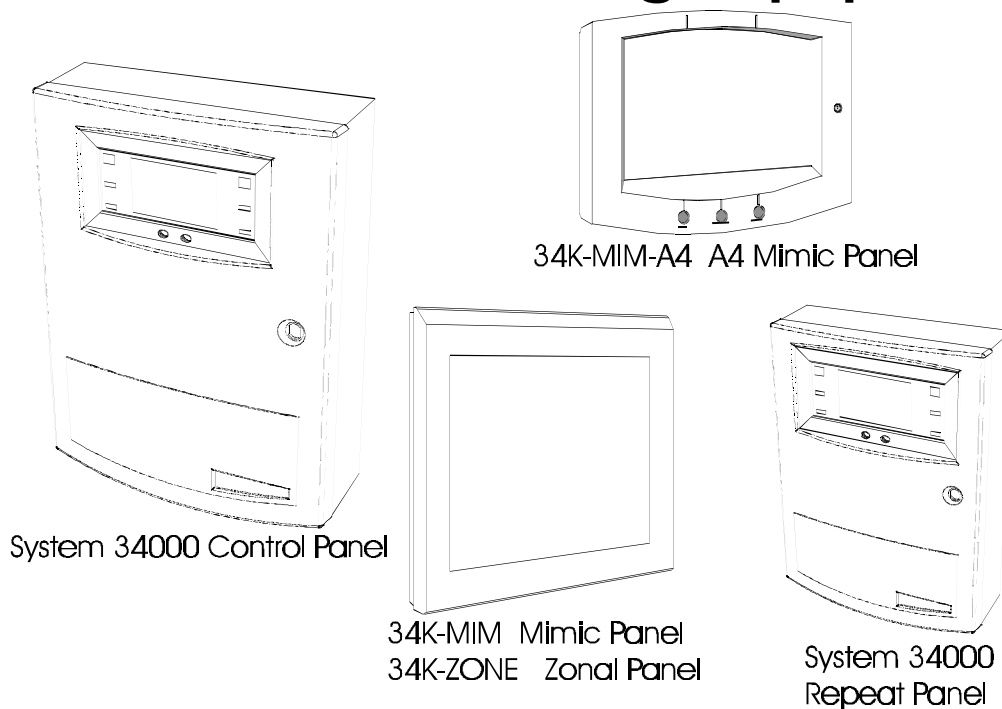

Figure 2-1 Control and indicating equipment  
cdn379

The System 34000 Control Panel is at the heart of a standalone fire detection and alarm system. It registers all event occurrences monitored by each device (system equipment) installed in a protected premise and co-ordinates the alarm actions based on the pre-configured system set up.

## Visual and audible Indications

### Control, Repeat and Terminal node

An event such as a Fire, Fault or Warning would automatically activate system indications. The control panel, repeat panel and terminal node indicate events by means of:

- messages on a display/ screen (Liquid Crystal Display - LCD)
- accompanied with illumination of appropriate colour coded light
- and an audible sound from within the panel given by a two tone buzzer.

### Mimic & Zonal panels

These panels provide indications by means of red fire indicators located behind a site map or zone designation. An internal buzzer provides an audible indication of a fire and local fault.

The A4 Mimic panel also has common lights that operates with fire, local power supply status and local faults.

**NOTE:** The A4 mimic panel has an internal buzzer disabling facility which is configured during commissioning of the system. If the buzzer is disabled then it will not sound in an event condition.

# Normal Condition

**Control & Repeat panels plus Terminal node**

A normal operating condition is when there is no fire, fault, warning or test condition present and the mains and standby power supplies to the equipment remains healthy. Under these conditions the display shows a Panel Healthy message and the green Power light is lit.

Figure 2-2 Normal indications

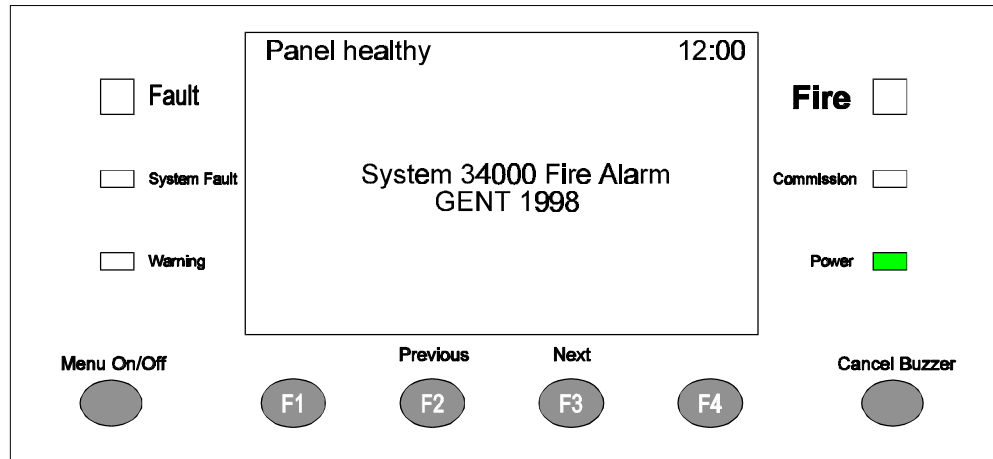

cdn381

**Mimic and Zonal panels**

**NOTE:** There are no indications given at the *standard Mimic and Zonal Panels* of system status.

The A4 mimic panel provides a common fire, local fault and local power supply status indications. There may also be a display of the system clock.

# Quick Reference

## First level controls

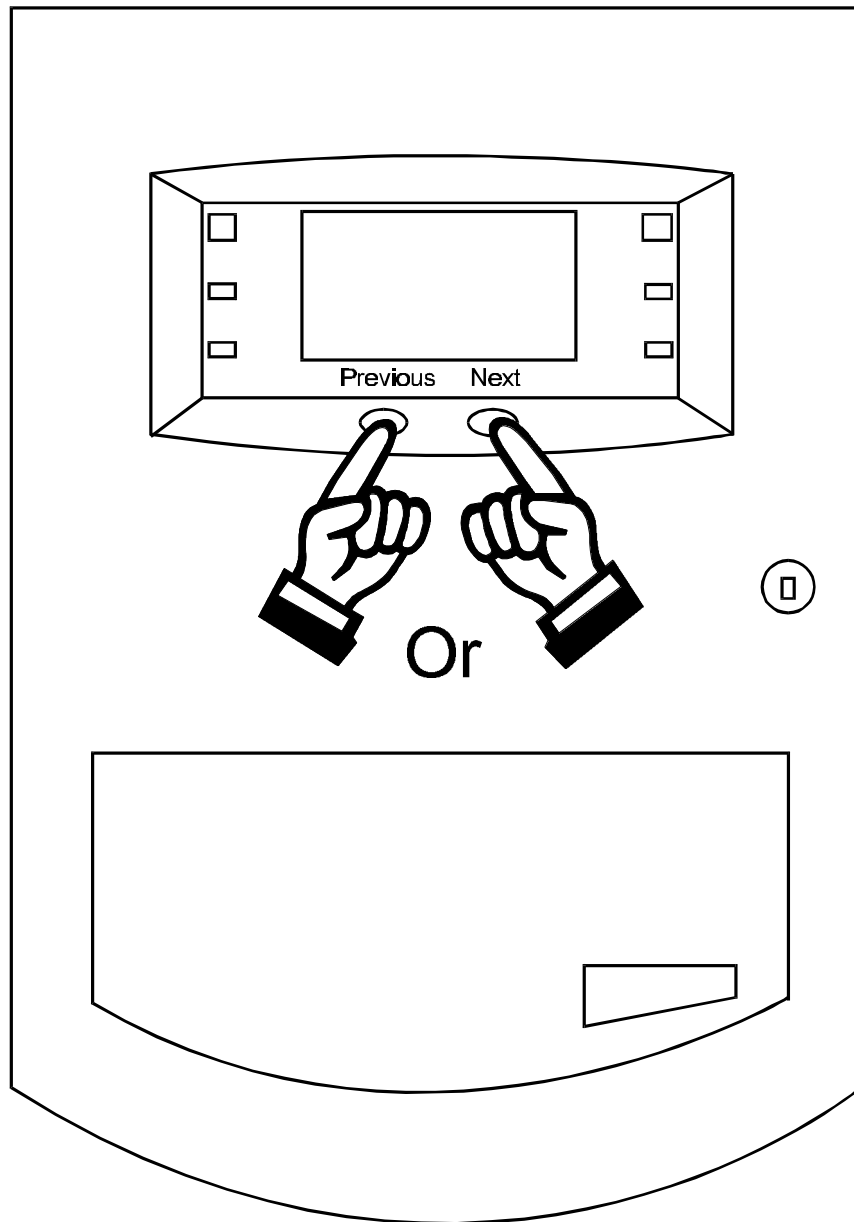

Figure 3-1 Controls accessible without opening door  
cdn295

The FIRE events displayed can be scrolled through by utilising the first level controls accessible without opening the moulded door. By pressing either Previous or Next as appropriate all current FIRE events can be displayed.

**System controls** Open the moulded door to find:

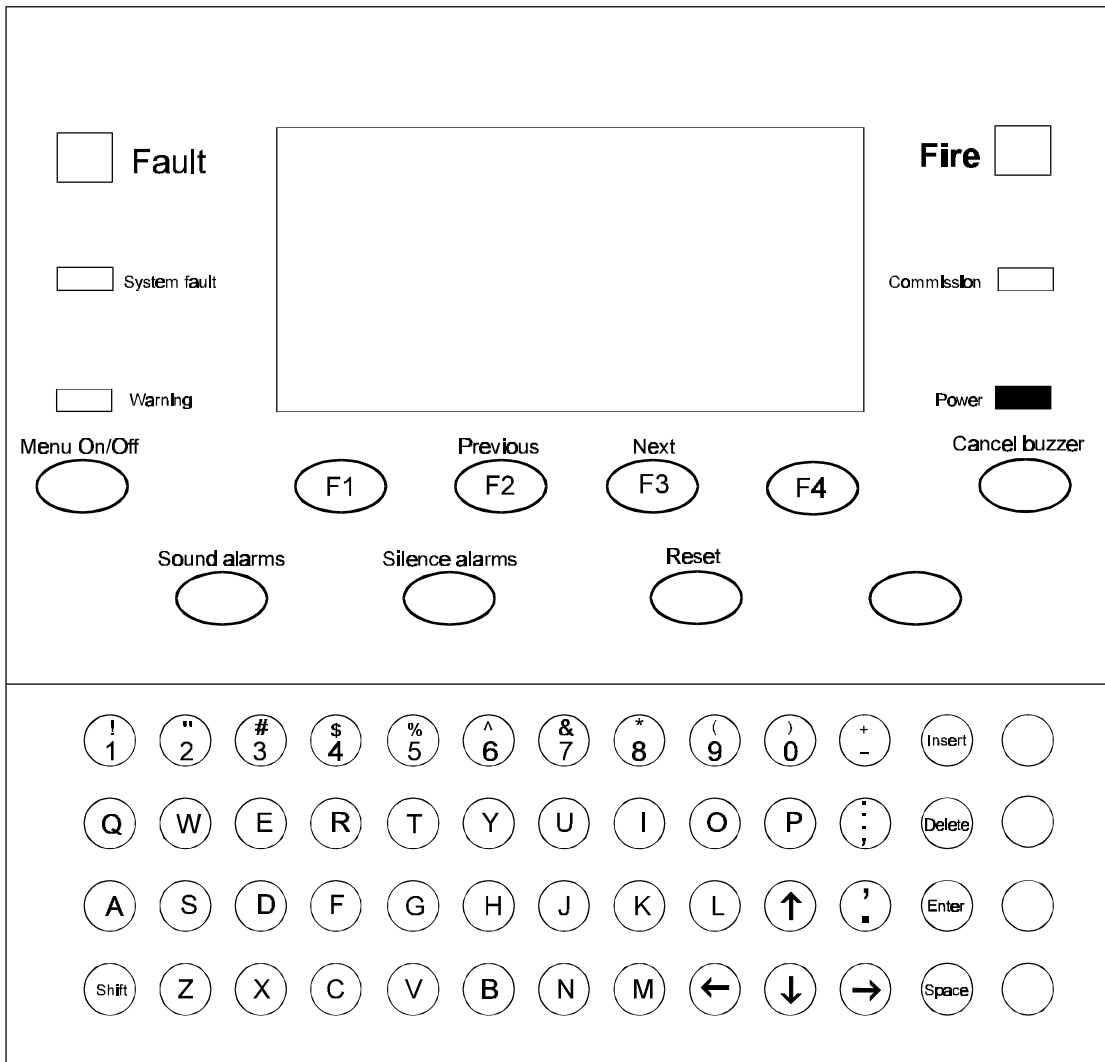

Figure 3-2 Control panel facia  
cdn292

**NOTE:** All customer controls described in this manual are accessible on opening the moulded door. The key which opens the door is usually accessible to persons responsible for the fire alarm system.

## Quick Reference Guide

The Quick Reference guide given on the following page can be copied and left in an easily accessible but secure place for use by appropriate personnel.

**How to manually raise an alarm of FIRE**

1. Operate nearest call point by breaking call point glass.

OR

2. Press the **Sound Alarms** button on the control panel to activate **ALL** sounders.

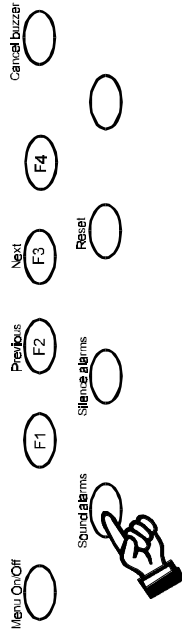

**In the event of a FIRE condition (Emergency over)**

1. To silence the alarms press the **Silence Alarms** button on the control panel.
2. To reset the system press the **Reset** button on the control panel.

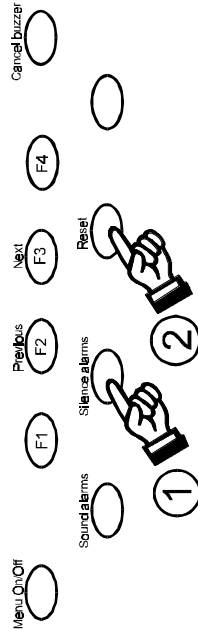

**In the event of a Fault condition**

1. To silence the buzzer press the **Cancel buzzer** button on the control panel, and report fault to responsible person.

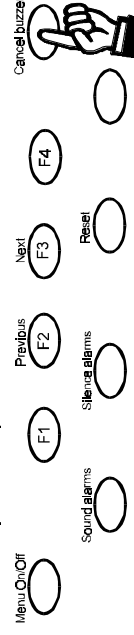

**In the event of a Warning condition**

1. Report fault to responsible person. The buzzer cannot be cancelled.

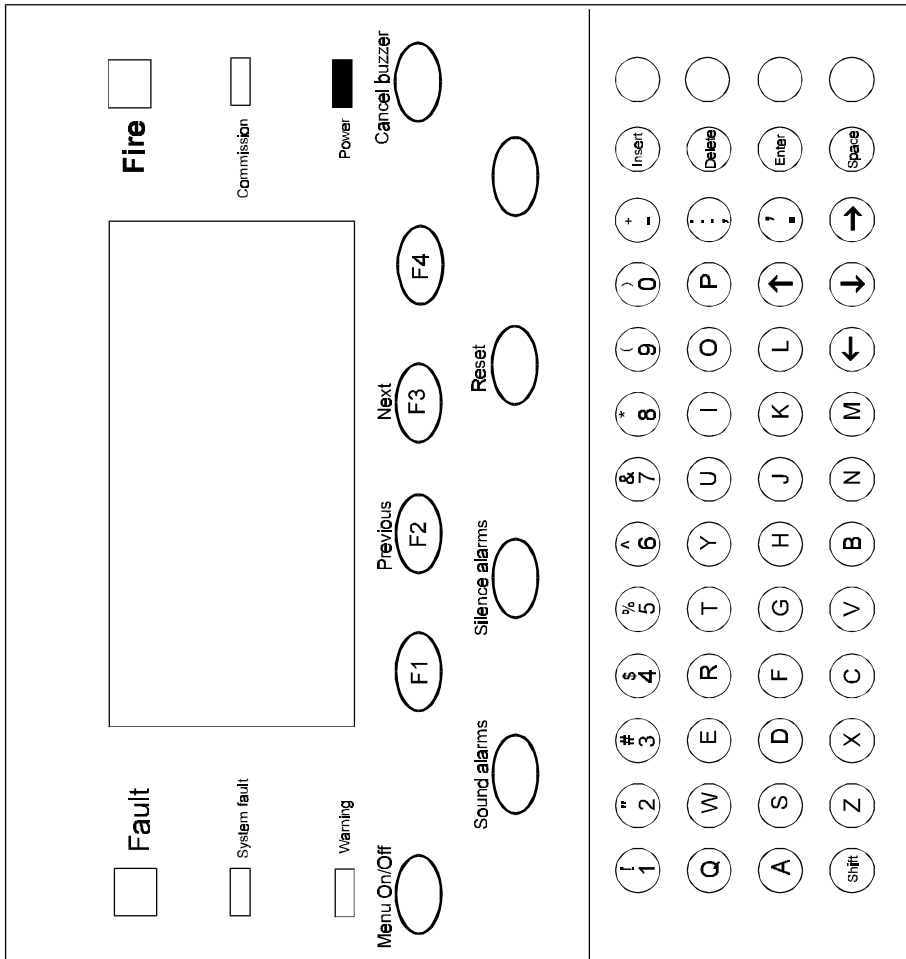

Figure 3-3 Quick Reference guide

---

This page has been left intentionally blank.



# Emergency Conditions

## How to raise an ALARM of Fire

### Manual call of fire

An alarm of fire can be raised by operating a manual call point.

- a) Go to the nearest manual call point that is located away from the fire hazard.
- b) Press hard with thumb onto the centre of the glass.

**NOTE:** The glass will crack vertically (due to a small score on its reverse side) and collapse into the call point.

**NOTE:** A clear label will hold the broken glass together to prevent injurious splinters.

### Automatic fire detection

A fire event is automatically detected by the Control Panel using data from the sensors and fire inputs from interface units in a standalone system.

An alarm is automatically actioned by the control panel based on preconfigured system setup.

# In the event of a FIRE Condition

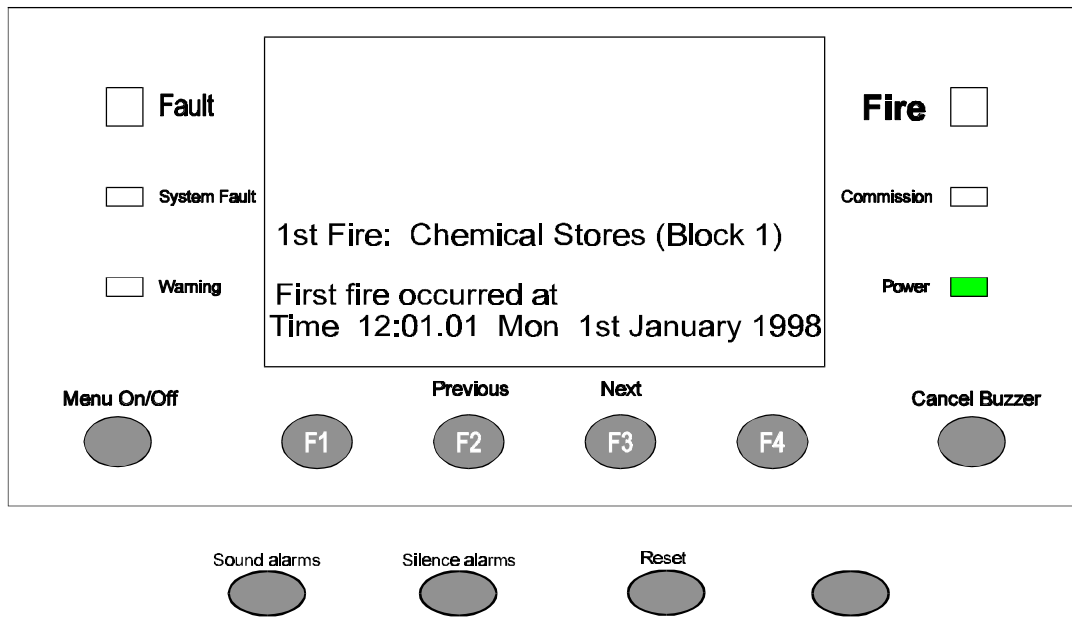

Figure 4-1 Fire indications and controls  
cdn296

These instructions are applicable for the following equipment:

Control panel	Repeat panel	Network Node
Yes	Yes	Yes

## To Silence Alarms

With the emergency over and to silence alarms :

Press the Silence Alarms button. Notice the alarms are silenced and the fire buzzer gives an intermittent sound and the display gives an 'Alarm Silenced' message.

## To Reset the System

### Resetting the system

Prior to resetting the fire alarm system, any excess heat and smoke must be cleared from the fire sensors initiating the fire conditions. Where a manual call point glass has been broken this must be replaced.

With the alarm activating device cleared for normal operation:

Press the Reset button. Notice the display provides the following message 'Sounders stopped System being Reset - please wait...'. The indications prior to the fire condition are resumed after a short delay.

## Fire Indications

In the event of a fire condition the system alarms are activated automatically. The Panels or Nodes in the system provides the following indications:

- the display shows time, date and location of fire event(s) and panel number is shown at the terminal node.
- Red fire light is lit
- Internal Fire Buzzer is active
- Printer provides a listing of events if it is On.

### Multiple Fires

The '1st fire' message is given at the top of the display. For multiple fires, all 'New Fire' events will appear beneath the '1st Fire'. The display will scroll the information automatically.

Should there be more fires then can appear on the display, the second line on the display will show NewFire information. Every four seconds the NewFire text will toggle to show the new fire number, e.g. Fire n.

**NOTE:** If a device label is not setup then the display shows the device (outstation) and loop number.

### Mimic & Zonal panels

A fire indication is given by illumination of lights behind the site plan or zone map, together with the local fire buzzer. A steady or flashing (first fire) indication is given in the event of a fire. The A4 mimic panel has a common fire light which will illuminate with a fire indication.

### Fire detection and indication

All fire events are automatically detected by the control panel using data from the fire sensing devices, such as the fire sensors, manual call points and interface fire inputs in the system.

**NOTE:** To prevent operator confusion all **Fault and Warning events** are not displayed by the control panel during a Fire Condition. These messages and light indications are inhibited until after the incident is over and the system is reset.

### Log Book

All fire events must be recorded in the Log Book provided.

### Control Menu

**NOTE:** When the Control Panel is in a fire condition, only some options of the [CONTROL] menu are accessible.

The [Control] menu provides the control of Master Alarms, Sector Alarms, Auxiliary Relays etc., see operating the MENU ON/OFF part of this manual. The disable and enable options not accessible during a fire condition.

### Fire Events Log

Each fire event is automatically logged in the Fire Events Log at the control panel and these events can be recalled using the [Info] menu. This menu is only accessible in non-fire condition.

# In the event of a FAULT condition

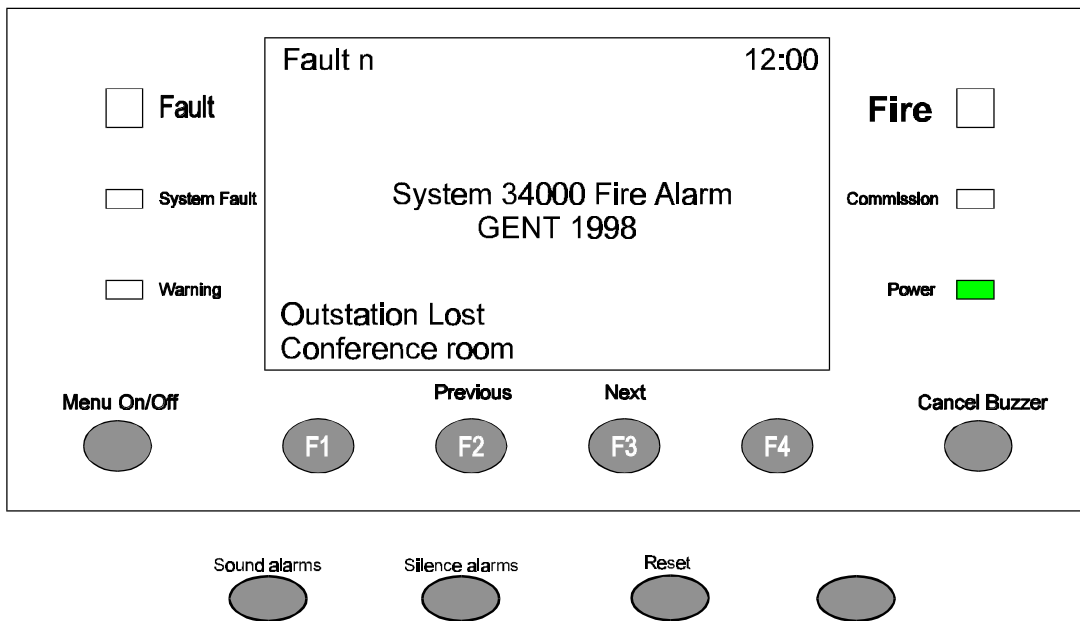

Figure 4-2 Fault indications and controls  
cdn382

These instructions are applicable for the following equipment:

Control panel	Repeat panel	Network Node
Yes	Yes	Yes

## To Cancel the Fault Buzzer

Press the Cancel Fault Buzzer button to stop the fault buzzer from sounding.

## Fault Indications

A fault condition occurs when there is a failure within the system that usually requires rectification action.

In the event of a fault condition:

- the Display shows the location of latest fault event, not indicated on the terminal node.
- Amber Fault light is lit
- Internal Fault Buzzer is active
- Printer provides a listing of events if it is On.
- Total number of active faults in the system appears in the top left of the display.

**NOTE:** The **Fault** light will give a flashing indication when the Control panels mains supply is unhealthy and the the **Power** light is Off.

**NOTE:** If the device label is not setup then the display shows the device outstation and loop number.

### Mimic and Zonal panels

An internal buzzer will sound when the Mimic or Zonal Panel has a local power supply failure or there is unsuccessful communications with the control panel. The buzzer may be cancelled by operating a keyswitch located on the bottom right hand side. The A4 mimic panel has no local silence fault buzzer facility.

### A4 Mimic panel

Under rare circumstances the A4 mimic panel may display fault codes such as, **COMMS FAULT**, these indications are primarily for use by engineers when commissioning the panel.

## Action to Rectify a Fault Event

- a) Read the message display for information on the fault event.
- b) Take necessary rectification action. All fault repair should be undertaken by engineers responsible for maintaining the fire system.
- c) If necessary contact your servicing organisation for advice.
- d) All fault events should be recorded in the Log Book provided.

### Fault detection and indication

All Fault events are automatically detected by the control panel using data from the system. Usually a fault event is generated as a result of abnormal performance for the system.

**NOTE:** To prevent operator confusion all Fault events are detected by the Control panel during a Fire Condition, however their indications are inhibited until after the incident is over and the system is reset.

### Multiple Faults

The number 'n' following the 'Fault' on the top left of the display, shows how many active fault events there are present in the fire alarm system.

### Fault Events

Each Fault event is automatically logged in the Historic Events Log at the Control panel and these events can be recalled using the [Info] menu. This menu is only accessible in a non-fire condition.

**NOTE:** The information in the active [Fault] events log is automatically cancelled when the condition is removed.

### During a Fire condition

**NOTE:** The messages and light indication of faults are inhibited during a fire condition.

**Fault messages**

The following table shows some fault messages, along with what they mean and possible rectification actions.

**NOTE:** The rectification actions must be attempted by a trained engineer. For advise contact your servicing organisation.

Message	Meaning	Action
<b>Mains failed</b>	The mains supply to the control panel has failed	Restore the mains supply to the control panel
<b>Battery discharged n</b>	The battery supply to the control panel has been fully discharged	Check the battery and replace if necessary
<b>Master Alarm(s) oc or sc n</b>	There is an open or short circuit fault on the master alarm wiring	Check the wiring and remove the fault. Ensure the end-of-line device is connected in the circuit.
<b>Wiring changed short circuit at card n</b>	There is a short circuit on the loop n wiring	Identify the outstation (device) where a cable fault has occurred and remove the fault.
<b>Interface input os / sc</b>	There is an open or short circuit on the input line of an interface	Locate and remove the wiring fault. Ensure the end-of-line device is connected in the circuit.
<b>Outstation Mains failed</b>	There is a mains supply failure at an interface unit, repeat panel or a mimic panel.	Check the fuse and mains supply to the equipment.
<b>Outstation Battery fault</b>	The battery supply at an interface unit, repeat panel or mimic panel has failed the load test	Check the battery and replace it if necessary

# In the event of a WARNING condition

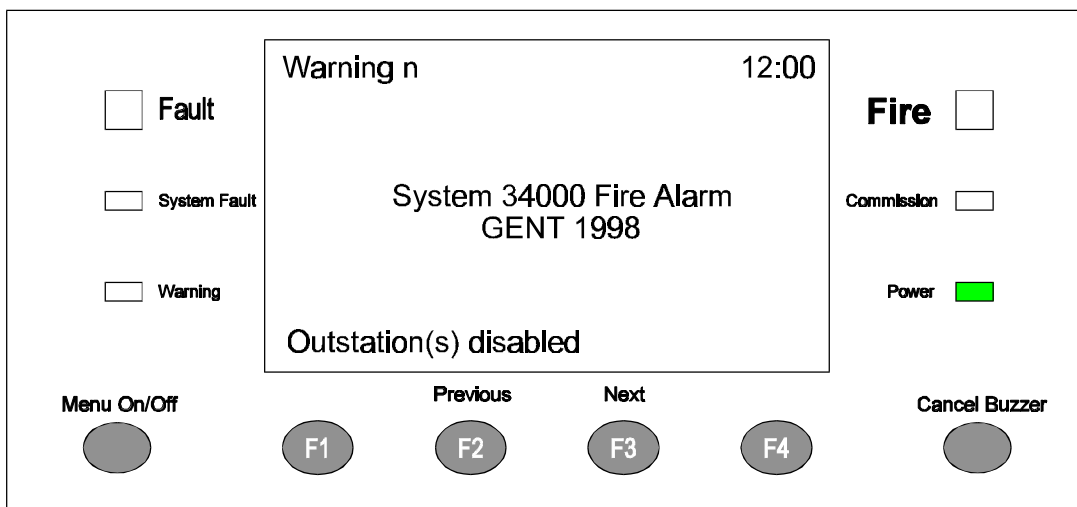

Figure 4-3 Warning Indications  
cdn383

These instructions are applicable for the following equipment:

Control panel	Repeat panel	Network Node
Yes	Yes	Yes

## Warning Indications

- A warning condition occurs when there is a disablement within the fire alarm system. The panels provides the following indications:
  - the Display shows latest warning event message, not indicated at a terminal node.
  - Amber Warning light is lit
  - Internal Warning Buzzer is active (gives an intermittent beep)
  - Total number of active warning in the system appears in the top left of the display.

**NOTE:** The warning light will give a flashing indication when the panels mains supply is unhealthy and the the Power light is Off.

## Action to Remove a Warning Event

- a) Read the message display for information on the warning event.

- b) Take necessary rectification action. All warning rectification should be undertaken by the engineer responsible for maintaining the system.
- c) If necessary contact your servicing organisation for advice.
- d) All warning events should be recorded in the Log Book provided.

**Warning detection and indication**

Warning events are automatically detected by the control panel using data from the system. Usually a warning event is generated if there has been a disablement of any part of the system.

***NOTE:** To prevent operator confusion, Warning events are detected by the Control panel during a Fire Condition, however their indications are inhibited until after the incident is over and the system is reset.*

**Multiple Warnings**

The number ‘n’ following the ‘Warning’ on top left of the display, shows how many active warning events there are present in the system.

**Warning Events**

Each Warning event is automatically logged in the Historic Events Log at the control panel and these events can be recalled using the [Info] menu. This menu is only accessible during non-fire conditions.

***NOTE:** The information in the active **Warning** events log is automatically cancelled when the condition is removed.*

**During a Fire condition**

***NOTE:** Messages and light indication of **warnings** are inhibited during a fire condition.*

**Warning messages**

The following table shows some warning messages, along with what they mean and possible rectification actions.

***NOTE:** The rectification actions must be attempted by a trained engineer. For advise call your servicing organisation.*

Message	Meaning	Action
Outstation disabled at card n	The device connected to the loop circuit have been manually or automatically disabled	If manually disabled then investigate and, if appropriate, re-enable the outstation
Sector disabled at card n	The fire alarm sector on loop n has been manually or automatically disabled	If manually disabled then investigate and, if appropriate, re-enable the sectors
Disabled Aux Relay n	The auxiliary relay n in the control panel has been manually or automatically disabled	If manually disabled then investigate and, if appropriate, re-enable the aux relay
Master alarms disabled	The master alarms have been manually or automatically disabled	If manually disabled then investigate and, if appropriate, re-enable the master alarms

# To sound all Fire Alarms globally

These instructions are applicable for the following equipment:

Control panel	Repeat panel	Network Node
Yes	Yes	No sound alarms

## To Sound Alarms

To sound all alarms of the fire system in an emergency:

Figure 4-4 Sound alarms

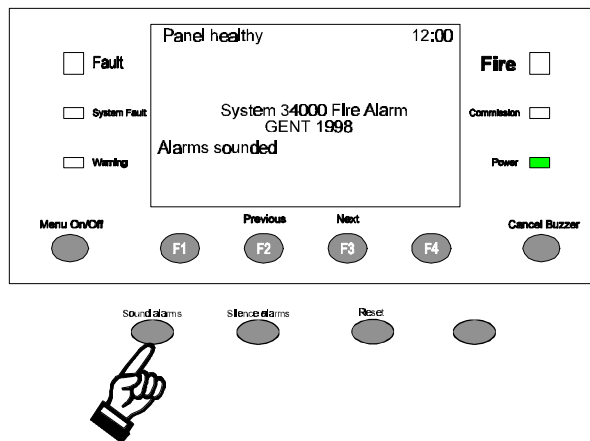

cdn384

Press the Sound Alarms button. Notice, the alarms of the fire system are sounding and the display gives the an ‘Alarms sounded’ message, plus the internal buzzer sounds.

## To Silence Alarms

With the emergency over the alarms can be silenced:

Figure 4-5 Silence Alarms

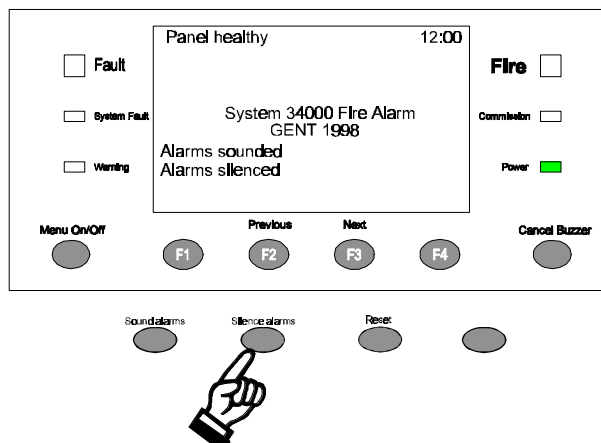

cdn385

Press the Silence Alarms button. Notice, the alarms of the fire system are silenced and the display gives the ‘Alarms silenced’ message, plus the internal buzzer is silenced.

**NOTE:** The printer will list this event if it is switched On.

## To sound the Master Alarms

These instructions are applicable for the following equipment:

Control panel	Repeat panel	Network Node
Yes	Yes	No

The Master alarms are conventional sounders normally installed near the control panel. The fire buzzer in the control panel will operate with the Master alarms, however in some applications the master alarms are not used.

To manually switch On or Off the Master alarms, plus internal (FIRE) buzzer.

- a) Press the MENU ON/OFF button and then the F1 button to select [Control].

- b) To start or stop the Master Alarm sounders:

To start the Master alarms:

Press the F1 key to select [Start MA]. This prompts a message on the display 'Start Master Alarms'.

To stop the Master alarms:

Press the F2 key to select [Stop MA]. This prompts a message on the display 'Stop Master Alarms'.

- c) Press the F2 key to select [Enter]. Notice the alarm action has been processed and a message appears on the display reading 'Master Sounder on/off'. Note also the internal buzzer sounds.

## To sound the Sector Alarms

These instructions are applicable for the following equipment:

Control panel	Repeat panel	Network Node
Yes	Yes	No

There can be up to 32 configured sectors per loop circuit. A sector can have fire sensors, manual call points, alarm sounders or interface input/outputs.

**CAUTION:** The sectors 28-32 are normally reserved for special applications such as for fire extinguishant control.

To manually switch a Sector to sound Signal 1, Signal 2, Signal 3 or Stop.

- a) Press the MENU ON/OFF button and then the F1 button to select [Control].

**NOTE:** If [UserCode] prompt is not displayed then the following step can be ignored.

- b) Press the F4 button to select [UserCode]. Notice a message on the display 'Enter access code' followed by a flashing cursor. Use the keyboard to input your access code and then press the Enter button.
- c) Press the F4 button to select <etc>.
- d) Press the F1 key to select [Sector]. Notice 'Sector' followed by a flashing cursor on the display. Use the keyboard to input a Sector number or range (1-32).
- e) Press the F2 button to select [loop]. Notice 'Loop' followed by a flashing cursor appears on the display. Use the full keyboard to input a Loop number or range (1-8).
- f) Press the F2 button to select [Action].
- g) To action Sector alarms:

To action Sector alarms signal 1, 2 or 3.

Press the F2, F3 or F4 button to select [Signal 1], [Signal 2] or [Signal 3]. Notice 'Signal 1', 'Signal 2' or 'Signal 3' appears on the display.

To stop Sector alarms

Press the F1 button to select [Off]. Notice 'Off From' appears on the display.

Press the F1 button to select [All], to stop all sector alarm signals or press F2, F3 or F4 button to stop sector alarms [Signal 1], [Signal 2] or [Signal 3].

- h) Press the F2 button to select [Enter]. Notice the selected action has been processed and a 'Sector actioned' message appears on the display.

This page has been intentionally left blank.



# Operating the MENU ON/OFF

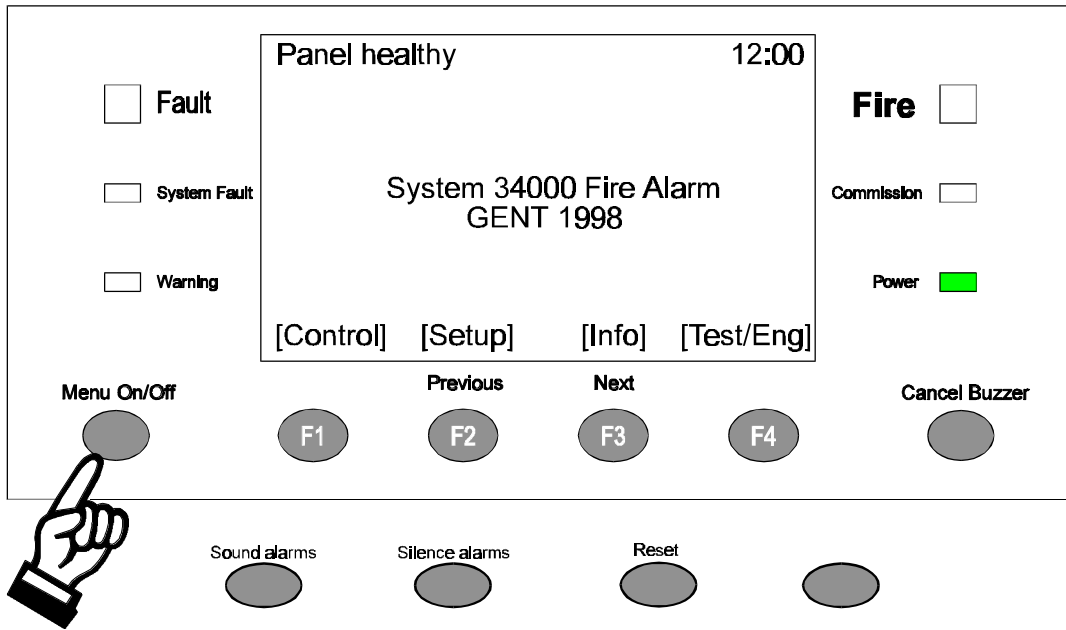

Figure 5-1 Top level menu

cdn386

The MENU ON/OFF button at the panel provides access to all menu options that are available under [Control], [Set Up], [Info] and [Test/Eng] menus.

**Function buttons**

The menu prompts appear on the bottom line of the display, above the function buttons to prompt the user to make a selection. The top level menu selection can be made by pressing one of the function button F1 to F4, which displays further sub level menu options for selection. When all the entries are made the action is carried out.

**Top level menu**

At any level in a menu tree press the MENU ON/OFF button to get out and to display the top level menu.

If the time taken between key presses exceed 5 minutes, the equipment will automatically remove the display and give a system status indications.

**Params**

The {Params} prompt is a 'HELP' facility that provides information to the user regarding the input data.

**NOTE:** Most functions under the top level menus are protected with an access code entry. The code is programmed during commissioning of the system and is passed on to the site persons responsible for the fire alarm system.

**Password access**

Where an access code is not set up, there is an open entry to operate controls under [User Code] and the instructions for entering access code are not applicable.

# Testing the display and indicators

These instructions are applicable for the following equipment:

Control panel	Repeat panel	Network Node
Yes	Yes	Yes

This facility allows automatic tests to be performed on the Lights, Display and the integral Buzzer.

- a) Press the MENU ON/OFF button and then the F4 button to select [Test/Eng].
- b) Press the F1 button to select [Disp Test]. Notice the automatic tests are conducted.

### Test Indications

- Lights are lit for approximately 2 seconds.
- Display clears for approximately 2 seconds and then give a system status message.
- Buzzer sounds a dual tone for approximately 2 seconds.

## Testing the Mimic and Zonal panels

### Standard Mimic and Zonal panels

At the standard Mimic and Zonal panels a lamp test can be performed by operating the keyswitch located on the bottom left side of the enclosure. The lights are tested in blocks on a row by row basis, starting from the bottom left of the display aperture.

While the test is operational, blocks of 64 lights switch On for 1 second duration before a next block of lights are tested. The lights may be kept switched On for 5 seconds by stopping the lamp test when it reaches the desired position in the display aperture.

Figure 5-2 Lamp test on standard mimic panel

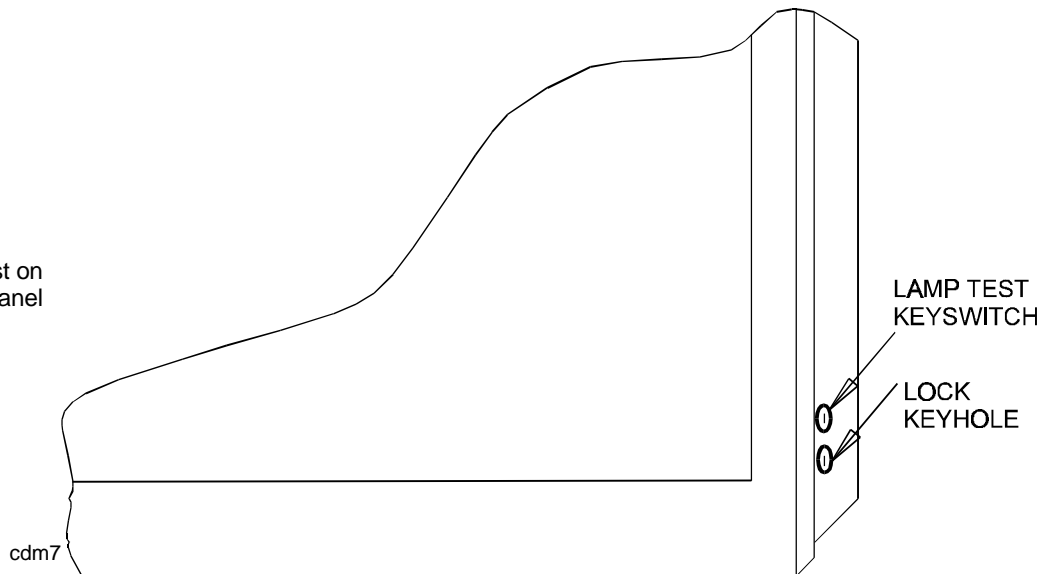

**A4 Mimic panel**

A lamp test is activated at an A4 mimic panel by inserting a 2mm rod like object (for example a small terminal screwdriver) into a hole located on the underside of the panel enclosure.

Figure 5-3 Lamp test at A4 Mimic panel

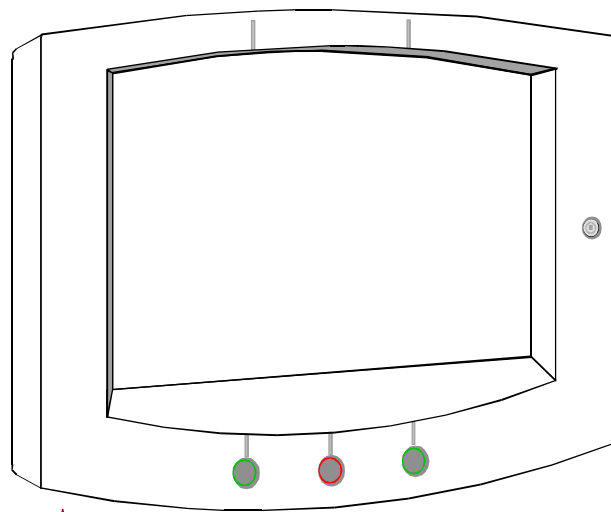

↑ insert a 2mm diameter pin (for example a small terminal screwdriver) into the hole to operate the lamp test switch

f1380

The lights are tested in blocks on a row by row basis, starting from the top left of the display aperture.

While the test is operational blocks of 64 lights are automatically switched On for 2 seconds duration before the next block of lights are tested.



# Setting the System Clock

These instructions are applicable for the following equipment:

Control panel	Repeat panel	Network Node
Yes	Yes	Yes

**CAUTION:** *Incorrectly set system clock would affect the time related fire sensor operation and also give incorrect event time information.*

The system clock is maintained by the control panel. The Time, Date, Month and Year can be set or adjusted .

- a) Press the MENU ON/OFF button and then the F2 button to select [Set up].
- b) Press the F4 button to select [UserCode]. Notice ‘User Code’ followed by a flashing cursor appears on the display. Use the keyboard to input your access code and then press the Enter button.
- c) Press the F1 button to select [Set Clock]. This provides a display of the system clock. Notice the ‘Hour’ digits are flashing and requires setting.

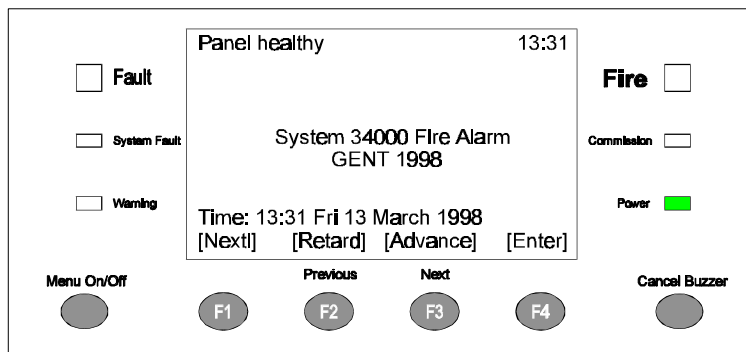

Figure 5-4 Set clock display  
cdn387

- d) Press the F2 or F3 button to [Retard] or [Advance] to a desired setting. A rapid change will occur with a continuous button press and a single step change with each individual button press.
- e) Press the F1 button to select [Next]. Notice the ‘Minute’ digits are now flashing.
- f) Follow the procedure in d) to adjust the Minutes setting.
- g) Press the F1 button to select [Next]. Notice the ‘Date’ digits are now flashing.

- h) Follow the procedure in d) to adjust the date setting. Notice days are automatically adjusted.
- i) Press the F1 button to select [Next]. Notice the 'Month' is now flashing.
- j) Follow the procedure in d) to adjust the Month setting.
- k) Press the F1 button to select [Next]. Notice the 'Year' is now flashing.
- l) Follow the procedure in d) to adjust the Year setting.
- m) Press the button F4 to select [Enter]. Notice the display now shows the new time and date.

***NOTE:*** All equipment displaying the clock and date information will update themselves with the new entries.



## Viewing the current Fire Log

These instructions are applicable for the following equipment:

Control panel	Repeat panel	Network Node
Yes	Yes	Yes

The [Fire] events log has the capability of storing up to 100 current and previous fire events. The logged information can be either called to the display or printed.

**NOTE:** *The newest fire is always event number 1 and the oldest fire can be event number 100.*

The logged information consists of time and date of each fire event together with label of the device initiating the fire detection. Further information may appear and can include outstation number (if its label is not set up), loop number, sector number, master sector, zone number and group (if setup), plus panel number for a network system.

- a) Press the MENU ON/OFF button and then the F3 button to select [Info].
- b) To display the event(s):  
Press the F1 button to select [Display]. Notice 'Display' appears on the display.  
  
To print the event(s):  
Press the F2 button to select [Print]. Notice 'Print' appears on the display.
- c) Press the F1 button to select [Fire]. Notice 'Fire' followed by a flashing cursor appears on the display.
- d) Use the keyboard to input a fire event number or range (1-100).
- e) Press the F2 button to select [Enter]. Notice the requested logged information is either displayed or printed.

**NOTE:** *With the printer switched Off, step b) and PRINT procedures are not applicable.*

## Viewing the current Fault Log

These instructions are applicable for the following equipment:

Control panel	Repeat panel	Network Node
Yes	Yes	Yes

The current [Fault] events log is held at each microprocessor controlled card. The logged information can be either printed or displayed.

The logged information consists of time and date of each fault event and the label of the device, if applicable. This data is automatically cancelled from the log when the condition is removed.

- a) Press the MENU ON/OFF button and then the F3 button to select [Info].
- b) To display the event(s):  
Press the F1 button to select [Display]. Notice 'Display' appears on the display, only if the printer is switched On.

To print the event(s):

Press the F2 button to select [Print]. Notice 'Print' appears on the display.

- c) Press the F2 button to select [Fault].
- d) Local System Fault:  
Press the F2 button to select [Enter]. Notice the requested logged information is either displayed or printed.

Card Fault:

Press the F3 button to select [Card]. Notice 'On Card' followed by a flashing cursor appears on the display. Use the keyboard to input a card number or range (0-15) and then press F2 to select [Enter].

To display Fault from another panel

Press the F4 button to select [Node]. Enter the node number using the keyboard and press the Enter button.

- e) Press the F2 or F3 button to select [Previous] or [Next] Fault. The events can be scrolled through to the desired fault event.

**NOTE:** With the printer switched Off, step b) and PRINT procedures are not applicable.

## Viewing the current Warning log

These instructions are applicable for the following equipment:

Control panel	Repeat panel	Network Node
Yes	Yes	Yes

The current [Warning] events log is held at each microprocessor controlled card. The logged information can be either printed or displayed.

The logged information consists of time and date of each warning event together with a message. This data is automatically cancelled from the log when a warning condition is removed.

- a) Press the MENU ON/OFF button and then the F3 button to select [Info].
- b) To display the event(s):  
Press the F1 button to select [Display]. Notice 'Display' appears on the display.  
  
To print the event(s):  
Press the F2 button to select [Print]. Notice 'Print' appears on the display, only if the printer is switched On.
- c) Press the F3 button to select [Warning].  
If printing the event(s): Notice 'Print Warning' followed by a flashing cursor appears on the display.
- d) Local System Warning:  
Press the F2 button to select [Enter]. Notice the most recent logged information is either displayed or printed.

### Card Warning:

Press the F3 button to select [Card]. Notice 'On Card' followed by a flashing cursor appears on the display. Use the keyboard to input a Card number or range (0-15) and then press the F2 button to select [Enter]. The requested information is either displayed or printed.

### To display Warning from another panel

Press the F4 button to select [Node]. Enter the node number using the keyboard and press the Enter button.

- e) For displayed events press the F2 or F3 button to select [Previous] or [Next]. The events can be scrolled through to the desired warning information.

**NOTE:** With the printer switched Off, step b) and PRINT procedures are not applicable.

## Viewing the Historic Log

These instructions are applicable for the following equipment:

Control panel	Repeat panel	Network Node
Yes	Yes	Yes

The [Historic] events log has the capability of storing up to 255 previous local event messages. The logged information can be printed or displayed.

**NOTE:** *The newest event is always event number 1 and the oldest can be event number 255.*

The logged information consists of the time and date of each event together with a message.

- a) Press the MENU ON/OFF button and then the F3 button to select [Info].
- b) To display the event(s):  
Press the F1 button to select [Display]. Notice 'Display' appears on the display.  
  
To print the event(s):  
Press the F2 button to select [Print]. Notice 'Print' appears on the display, only if the printer is switched On.
- c) Press the F4 button to select <etc>.
- d) Press the F1 button to select [Events]. Notice 'Events' followed by a flashing cursor appears on the display.
- e) Use the keyboard to input an event number or range (1-255).
- f) Press the F2 button to select [Enter] and notice the requested logged information is either displayed or printed.

**NOTE:** *With the printer switched Off, step b) and PRINT procedures are not applicable.*

# Viewing Supervisory Active Events

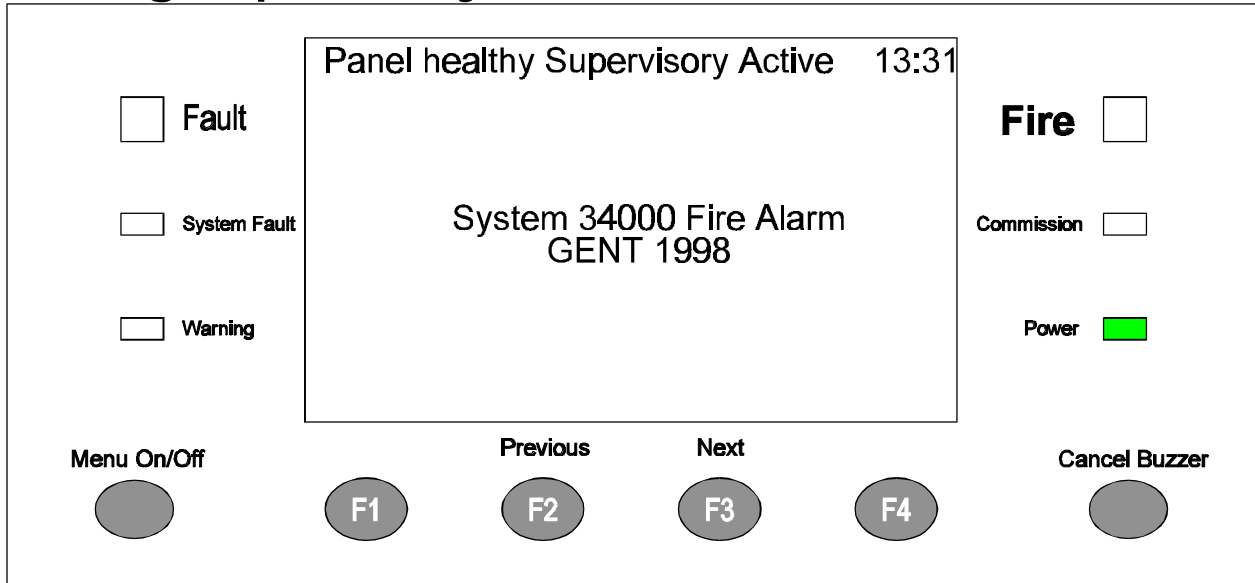

Figure 5-5 Supervisory active  
cdn388

These instructions are applicable for the following equipment:

Control panel	Repeat panel	Network Node
Yes	No	Yes

A [Supervisory] active event occurs when a non fire action (via command build) has been triggered and is currently in operation.

**NOTE:** Where no label is set up for a command build, the event does will show up as a **supervisory active event**.

To print or display the Supervisory Active information.

- a) Press the MENU ON/OFF key and then the F3 key to select [Info] and then the F4 key to select <etc>.
- b) To display event(s):  
Press the F1 key to select [Display]. Notice 'Display' appears on the display.

To print event(s):  
Press the F2 key to select [Print]. Notice 'Print' appears on the display.

For a display:  
Press the F4 key to select <etc>.  
Press the F3 key to select [Usercode].  
Press the F1 key to select [Supervis]. Notice 'Display Supervis' appears on the display.

Press the F1 key to select [Active]. Notice 'Display Supervis Active' appears on the display.

For a printout

Press the F4 key to select <etc>.

Press the F3 key to select [Usercode].

Press the F1 key to select [Supervis]. Notice 'Print Supervis' appears on the display.

Press the F1 key to select [Active]. Notice 'Print Supervis Active' appears on the display.

- c) Press the F2 key to select [Enter]. Notice the time and date, Command Build label and the triggering method are displayed.

**NOTE:** *With the printer switched Off, step b) and PRINT procedures are not applicable.*



## Viewing the Supervisory log

These instructions are applicable for the following equipment:

Control panel	Repeat panel	Network Node
Yes	No	Yes

The [Supervisory] log has the capacity of storing up to 255 previously actioned command build events. The logged information can be displayed or printed. The newest actioned command is always event 1 and the oldest event is up to 255.

The information that can be recalled will show the command build block number, its label (if set up), the On time and date of the activation, the trigger device and the Off time and date.

**NOTE:** *Command builds triggered by timeblocks will not be written to the log.*

To obtain Supervisory information

- a) Press the MENU ON/OFF key and then the F3 key to select [Info].
- b) To display the event(s):  
Press the F1 key to select [Display]. Notice 'Display' appears on the display.

To print the event(s):

Press the F2 key to select [Print]. Notice 'Print' appears on the LCD.

For a display:

Press the F4 key to select <etc>.

Press the F3 key to select [Usercode].

Press the F1 key to select [Supervis]. Notice 'Display Supervis' appears on the display.

Press the F2 key to select [Log]. Notice 'Display Supervis Log' appears on the display followed by a flashing cursor.

For a printout:

Press the F4 key to select <etc>.

Press the F3 key to select [Usercode].

Press the F1 key to select [Supervis]. Notice 'Print Supervis' appears on the display.

Press the F2 key to select [Log]. Notice 'Print Supervis Log' appears on the display followed by a flashing cursor.

- c) Use the full keyboard to input a supervisory event number or range (1-255).
- d) Press the F2 key to select [Enter]. Notice the required information is displayed or printed.

**NOTE:** *With the printer switched off, step b) and PRINT procedures are not applicable..*

## Changing the UserCode Password

These instructions are applicable for the following equipment:

Control panel	Repeat panel	Network Node
Yes	Yes	Yes

A password is required to gain access to options under [UserCode] . A new password can be created or a previously created one can be changed.

A password access prevents unauthorised use of options under [UserCode], that exist in the [Control], [Set Up], [Info] and [Test/Eng] menus.

**NOTE:** *The password can be up to 15 characters in length..*

- a) Press the MENU ON/OFF button and then the F4 button to select [Test/Eng].
- b) Press the F4 button to select [UserCode].
- c) Use the keyboard to input your existing access code and then press the Enter button.
- d) Press the F4 key to select <etc>, until 'newpass' is displayed.
- e) Press the F1 button to select [New Pass]. Notice a message on the display 'Enter new access code' with a flashing cursor above it.
- f) Use the keyboard to input a new access code and then press the Enter button. Notice 'New access code set up' appears on the display.

**NOTE:** *Changes to the User Code password at the Control panel is stored on Card O, the card must therefore be backed-up to the Memory Card. If this is not done then the previous password will be restored when a reset is performed.*

**NOTE:** *It is not possible to backup the passwords at repeat panel and terminal node.*

## Using the Printer

These instructions are applicable for the following equipment:

Control panel	Repeat panel	Network Node
Yes	No	Yes

The integral printer normally provides a listing of system events. The listing is performed automatically upon occurrence of each event, assuming the printer is switched On.

***NOTE:** If the printer is switched On permanently, then it will printout occurrence of every event. To prevent waste of paper it may be appropriate to print only when necessary.*

A printout is provided when the [Print] option has been selected after entering [Info] menu.

If the printer is On then it can be switched Off, or it can produce an automatic paper feed or an automatic printer test. If however the printer is Off then it can only be switched On.

- a) Press the MENU ON/OFF button and then the F1 button to select [Control].
- b) Press the F4 button to select [UserCode]. Notice a flashing cursor and a message on the display 'Enter access code'.
- c) Use the keyboard to input your access code and press Enter button.
- d) Press the F4 button twice to select <etc>.
- e) Press the F1 button to select [Printer]. Notice 'Printer' appears on the display.
- f) To switch On the Printer:  
Press the F3 button to select [On] and then the F2 button to select [Enter]. Notice 'Printer is on' appears on the display to show the action has been successfully carried out. Also notice the printer provides a listing of this event.
- g) To action an Automatic Paper Feed:  
With the printer switched on, repeat a) to e). Press the F2 button to select [Paper Fd] and notice the messages and the menu prompts are cleared. The printer then performs eight line feeds.

To conduct a Printer Test:

Press the F1 button to select [Test]. Notice the messages and menu prompts are cleared. A listing is provided by the printer of all the alphanumeric characters it can print.

- h) To switch Off the Printer:  
Repeat a) to e). Press the F3 button to select [Off] and then the F2 button to select [Enter]. Notice 'Printer is off' appears on the display to confirm the action has been successful. Also notice the printer provides a listing of this event.

## Editing Label Information

These instructions are applicable for the following equipment:

Control panel	Repeat panel	Network Node
Yes	No	Only panel label

A label is used to identify the location a system device such as an Outstation like a fire sensor, alarm sounder, manual call point, repeat panel, and interface unit - including input/output lines. A label of up to 32 alphanumeric characters can be given to a system device, however for a Manual Call Point there can only be up to 28 characters.

A label can be created using [Enter] and a previously created label can be modified using [Modify]. Use the Information menu to check any previously entered label.

**NOTE:** Changes or entry of label should be backed up to the Memory Card.

### Outstation Label

An outstation is a system device like a fire sensor, manual call point, interface unit, repeat panel or alarm sounder.

- a) Press the MENU ON/OFF button and then the F2 button to select [Set Up].
- b) Press the F4 button to select [UserCode]. Notice a message on the display 'Enter access code', followed by a flashing cursor.
- c) Use the keyboard to input access code and then press Enter button.
- d) Press the F4 button once to select <etc>.
- e) Use the left and right arrow buttons to move the cursor to the text to be edited.  
To modify an existing label: Press the F1 button to select [Modify] and notice 'Modify' appears on the display.  
  
To enter a new label: Press the F2 button to select [Enter] and notice 'Enter' appears on the display.
- f) Press the F1 button to select [Label] and notice 'Label' appears on the display.
- g) Press the F3 button to select [Outstatn]. Notice 'OutStatn' followed by a flashing cursor appears on the display.
- h) Use the keyboard to input an outstation number or range (1-191).

- i) Press the F2 button to select [Loop]. Notice 'Loop' followed by a flashing cursor on the display.
- j) Use the full keyboard to input a loop number or range (1-8).
- k) Press the F2 button to select [Enter].

If modifying a label: Notice the previous label appears on the display with a flashing first character to prompt the modification.

If entering a new label: Notice the flashing cursor for entry of label information.

- l) Use the keyboard to input a label and then press the Enter button. Notice a message on the display 'Card n Set Up'.

### **Input/Output Line label**

Each input/output line of an interface unit can be given a label and a previously entered label can be modified.

- a) Follow the Outstation label procedure a) to f) .
- b) Press the F2 button to select [IO Line]. Notice 'IO Line' followed by a flashing cursor on the display.
- c) Using the keyboard enter an input/output number or range (1-4).
- d) Follow the Outstation label procedure g) to l).

### **Group label**

Each group can be given a label and an entered label can be modified.

- a) Follow the Outstation label procedure a) to f) .
- b) Press the F4 button once to select <etc>.
- c) Press the F1 button to select [Group]. Notice 'Group' followed by a flashing cursor appears on the display.
- d) Using the keyboard enter a number or range (1-128).
- e) Follow the Outstation label procedure k) to l).

### **Local panel label**

Each control panel and terminal node in a network can be given a label and a previously entered label can be modified.

- a) Follow the Outstation label procedure a) to f) .
- b) Press the F4 button once to select <etc>.
- c) Press the F2 button to select [Local]. Notice 'local' appears on the display.
- d) Follow the Outstation label procedure k) to l).

## Viewing Labels

These instructions are applicable for the following equipment:

Control panel	Repeat panel	Network Node
Yes	No	Only panel label

The identification label given to each system device, such as an Outstation like a fire sensor, alarm sounder, manual call point, repeat panel, and interface unit - including input/output lines, plus group and local panel labels can be checked. The information can either be displayed or printed.

**NOTE:** With printer switched Off, step b) and PRINT procedures are not applicable.

### Outstation Label

- a) Press the MENU ON/OFF button and then the F3 button to select [Info].
- b) A label can be displayed or printed.  
  
 To display an outstation label:  
 Press the F1 button to select [Display]. Notice 'Display' appears on the display.  
  
 To print an outstation label:  
 Press the F2 button to select [Print]. Notice 'Print' on the display
- c) Press the F4 button to select <etc> and then the F2 button to select [Label]. Notice 'Label' appears on the display.
- d) Press the F3 button to select [OutStatn]. Notice 'Outstatn' followed by a flashing cursor appears on the display.
- e) Use the full keyboard to input an outstation number or range (1-191).
- f) Press the F2 button to select [Loop]. Notice 'Loop' followed by a flashing cursor appears on the display.
- g) Use the full keyboard to input a loop number or range (1-8).
- h) Press the F2 button to select [Enter]. Notice the selected label information is either displayed or printed.

### Input/Output line Label

An interface unit has four input/output lines. Each line can be given a label that appears on the display during an event.

- a) Follow the procedure for Outstation label from a) to c).
- b) Press the F2 button to select [IO Line]. Notice 'IO Line' followed by a flashing cursor on the display.

- c) Use the keyboard to enter an input/output number or range (1-4).
- f) Press the F2 button to select [Outstatn]. Notice 'Outstatn' followed by a flashing cursor on the display.
- g) Follow the procedure for Outstation label from e) to h).

**Group label**

- a) Follow the procedure for Outstation label from a) to c).
- b) Press the F4 button once to select <etc>.
- c) Press the F1 key to select [Group] and notice 'Group' followed by a flashing cursor appears on the display.
- d) Use the full keyboard to input a Group number or range (1-128).
- e) Press the F2 key to select [Enter]. Notice the selected label information is either displayed or printed.

**Local Panel  
label**

- a) Follow the procedure for Outstation label from a) to c).
- b) Press the F4 button once to select <etc>.
- c) Press the F2 key to select [Local], notice 'Local' appears on the display.
- d) Press the F2 key to select [Enter]. Notice the selected label information is either displayed or printed.

## Saving changes to the Memory Card

These instructions are applicable for the following equipment:

Control panel	Repeat panel	Network Node
Yes	No	No

Any changes made to Labels or Password should be saved in the Memory Card.

- a) Press the MENU ON/OFF button and then the F2 button to select [Set Up].
- b) Press the F4 button to select [UserCode]. Notice a flashing cursor and a message on the display 'Enter access code'.
- c) Use the full keyboard to input your access code and then press the Enter button.
- d) Press the F4 button once to select <etc>.
- e) Press the F3 button to select [Save]. Notice 'Save All Data To RAM Card' appears on the display.
- f) Press the F2 button to select [Enter].
- g) Observe confirmation messages as each card is backed up.

**NOTE:** The changes can only be backed up to Memory Card if no warnings are present on the system.

# Enabling or Disabling Parts of the System

These instructions are applicable for the following equipment:

Control panel	Repeat panel	Network Node
Yes	Yes	Only card comms

To manually enable or disable the operation of outstations, interface input lines, sectors, zones, auxiliary relays, master sectors and card communications.

**WARNING:** *Disabling an extinguishant interface outstation does not disable the outstation outputs from operating. Hence the extinguishant agent could be released. However the disabling of the appropriate sectors (reserved for extinguishant applications) would prevent outputs operating on fire.*

**CAUTION:** *Sectors reserved for extinguishant applications can be manually operated using the control menu.*

**CAUTION:** *It is **only** possible to disable a Manual Call Points (MCP) by disabling the MCP outstation. Disabling MCP is however, not recommended.*

## Enable/Disable Outstations

- a) Press the MENU ON/OFF key and then the F1 button to select [Control].
- b) Press the F4 button to select [UserCode]. Notice a flashing cursor and a message on the display 'Enter access code'.
- c) Use the keyboard to input your access code and then press the Enter button.
- d) To disable or enable an outstation.

To disable:

Press the F2 button to select [Disable]. This puts a 'Disable' on the display.

To enable:

Press the F1 button to select [Enable]. This puts an 'Enable' on the display.

- e) Press the F1 button to select [OutStatn]. Notice 'Outstatn' followed by a flashing cursor appears on the display.

- f) Use the keyboard to input an outstation number or range (1-191).
- g) Press the F2 button to select [Loop]. Notice 'Loop' followed by a flashing cursor on the display.
- h) Use the keyboard to input a loop number or range (1-8).
- i) Press the F2 button to select [Enter]. Notice the action has been processed and confirmed by a message either: 'Outstation(s) enabled' or 'Outstation(s) disabled'.

**NOTE:** Upon disablement of any system equipment the warning light will be lit and the internal buzzer will sound intermittently

### Enable/Disable Input/Output Line(s)

There are four input/output lines on an interface unit and each line can be disabled or enabled.

**CAUTION:** An output line of an interface unit is normally assigned to a sector. The output line can only be disabled by disabling that sector, which has the affect of also disabling all other devices (outstations) in the sector.

- a) Follow the procedure to enable/disable outstation from a) to d).
- b) Press the F2 button to select [IO Line]. Notice 'IO Line' followed by a flashing cursor appears on the display.
- c) Use the keyboard to input IO line number or range (1-4).
- d) Press the F2 button to select [OutStatn]. Notice 'OutStatn' followed by a flashing cursor appears on the display.
- e) Use the keyboard to input an outstation number or range (1-191).
- f) Press the F2 button to select [Loop]. Notice 'Loop' followed by a flashing cursor on the display.
- g) Use the keyboard to input a loop number or range (1-8).
- h) Press the F2 button to select [Enter]. Notice the action has been processed and a message appears on the display 'IO line disabled/enabled at Card n'.

**NOTE:** The warning light will be lit upon disablement of any system equipment and the internal buzzer sounds intermittently.

**Enable/Disable  
Auxiliary Relays**

There are two auxiliary relays in the control panel whose operation can be disabled or enabled.

- a) Follow the procedure to enable/disable outstation from a) to d).
- b) Press the F4 button twice to select <etc> and then press the F2 button to select [Aux Rly]. Notice 'Aux Rly' followed by a flashing cursor appears on the display.
- c) Use the keyboard to input an auxiliary relay number or range (1-2).
- d) Press the F2 button to select [Enter]. Notice the action has been processed. Notice the action has been processed and a message appears on the display 'Aux Rly n disabled/enabled'.

**NOTE:** *The warning light will be lit upon disablement of any system equipment and the internal buzzer sounds intermittently.*

**Enable/Disable  
Master Alarm**

There are two master alarm circuits in the control panel whose operation can be disabled or enabled.

- a) Follow the procedure to enable/disable outstation from a) to d).
- d) Press the F4 button twice to select <etc> and then press the F1 button to select [MAalarm]. Notice 'Master Alarms' appears on the display.
- c) Press the F2 button to select [Enter]. Notice the action has been processed and a message appears on the display 'Master sounder disabled/enabled'.

**NOTE:** *The warning light will be lit upon disablement of any system equipment and the internal buzzer sounds intermittently.*

**Enable/Disable  
Sectors**

There can be up to 32 sectors per loop configured in a fire alarm system. A sector operation can be disabled or enabled.

- a) Follow the procedure to enable/disable outstation from a) to d).
- b) Press the F3 button to select [Sector]. Notice 'Sector' appears on the display followed by a flashing cursor.
- c) Use the keyboard to input a sector number or range (1-32).
- d) Press the F2 button to select [Loop]. Notice 'Loop' followed by a flashing cursor on the display.
- e) Use the keyboard to input a loop number or range (1-8).
- f) Press the F2 button to select [Enter]. Notice the action has been processed and a message appears on the display 'Card n set up'.

**NOTE:** The warning light will be lit upon disablement of any system equipment and the internal buzzer sounds intermittently.

### Enable/Disable Zone

There can be up to 128 zones configured in a fire alarm system. The zone operation can be disabled or enabled.

**NOTE:** Disabling a zone does not disable manual call points in the zone. Therefore a fire alarm of fire can be raised by operating a call point in a disabled zone.

- a) Follow the procedure to enable/disable outstation from a) to d).
- b) Press the F4 button to select <etc> and then press the F2 button to select [Zone]. Notice 'Zone' appears on the display followed by a flashing cursor.
- c) Use the keyboard to input a zone number or range (1-128).
- d) Press the F2 button to select [Enter]. Notice the action has been processed and a message appears on the display 'Zone n enabled or disabled'.

**NOTE:** The warning light will be lit upon disablement of any system equipment and the internal buzzer sounds intermittently.

### Other Enable/Disable options

Similarly it is possible to enable or disable Command Builds, Groups, Master Sector and Communications.

# Switching the Auxiliary Relays

These instructions are applicable for the following equipment:

Control panel	Repeat panel	Network Node
Yes	Yes	No

These are two Auxiliary Relays within the Control Panel, each having twin change over contacts. They are normally configured to operate with sector, fault or warning. However they can be manually switched On or Off.

## To Switch the Auxiliary Relay

- a) Press the MENU ON/OFF button and then the F1 button to select [Control].
- b) Press the F4 button to select [UserCode]. Notice a flashing cursor and a message on the display 'Enter access code'.
- c) Use the full keyboard to input your access code and then press the Enter button.
- d) Press the F4 button to select the <etc>.
- e) Press the F3 button to select [Aux Rly]. Notice 'Aux Rly' followed by a flashing cursor appears on the display.
- f) Use the keyboard to input an auxiliary relay number or range (1-2).
- g) Press the F2 or F3 button to select [On] or [Off]. Notice 'On' or 'Off' appears on the display.
- h) Press the F2 button to select [Enter]. Notice the action has been processed and a message appears on the display 'Auxiliary relay n On/Off'.

## Viewing Cards Information

These instructions are applicable for the following equipment:

Control panel	Repeat panel	Network Node
Yes	Its respective control panel	Yes

The status of each card in the control panel, such as the Loop Processor Card, Local Controller Card, IO Card or Memory Card can be displayed or printed.

The information can be printed or displayed and includes card type, the card slot position, number of faults and warnings on it and software version number with its date of release. A loop card will have the number of outstation found and how many are Tee Breakers.

### Card Status Information

- a) Press the MENU ON/OFF button and then the F3 button to select [Info].
- b) To display the card status:  
Press the F1 button to select [Display]. Notice 'Display' appears on the display and sub menu appears for selection.  
To print the card status:  
Press the F2 button to select [Print]. Notice 'Print' appears on the display.
- c) Press the F4 button once to select <etc>
- d) Press the F3 button to select [UserCode]. Notice a flashing cursor and a message on the display 'Enter access code'.
- e) Use the keyboard to input your access code and then press the Enter button.
- f) Press the F2 button to select [CardStat]. Notice 'Display (or Print) Card Status' followed by a flashing cursor appears on the display.
- g) Use the full keyboard to input a card number or range (0-15).
- h) To view cards information from local panel  
Press the F2 button to select [Enter]. Notice the requested card status information is either displayed or printed.

To view cards information from another panel

Press the F4 button to select [Node]. Enter the node number using the keyboard and press the Enter button.

**NOTE:** With the printer switched Off, step b) and PRINT procedures are not applicable.

## Viewing a Loop Map

These instructions are applicable for the following equipment:

Control panel	Repeat panel	Network Node
Yes	No	No

The map information of each loop circuit can be displayed or printed. It includes the address of each device on the loop together with address of the connecting previous, next and common line (Tee breaker) devices.

- a) Press the MENU ON/OFF button and then the F3 button to select [Info].
- b) To display the loop map  
Press the F1 button to select [Display]. Notice 'Display' appears on the display and a new sub menu appears.  
  
To print the loop map  
Press the F2 button to select [Print]. Notice 'Print' appears on the display.
- c) Press the F4 button once to select <etc>.
- d) Press the F3 button to select [UserCode]. Notice a message on the display 'Enter access code' followed by a flashing cursor.
- e) Use the full keyboard to input your access code and then press Enter button.
- f) Press the F4 button to select <etc>.
- g) Press the F2 button to select [Map]. Notice 'Map' followed by a flashing cursor appears on the display.
- h) Press F2 to select [Loop map]. Notice 'Loop map' followed by a flashing cursor on the display.
- j) For a complete loop map:  
Use the keyboard to input a loop number or range (1-8) and then press the F3 button to select [Enter].

For a range of outstations on a loop:

Use the keyboard to input a loop number or range (1-8) and then press the F2 button to select [OutStatn]. Notice 'Outstatn' followed by a flashing cursor appears on the display. Use the keyboard to input outstation number or range (1-191) and then press the F2 button to select [Enter].

Notice a loop map is either printed or displayed.

## Viewing Network Map

These instructions are applicable for the following equipment:

Control panel	Repeat panel	Network Node
Yes	No	Yes

The map information of panels and nodes can be displayed or printed. It includes the panel number relative to the network controller.

- a) Press the MENU ON/OFF button and then the F3 button to select [Info].
- b) To display the loop map  
Press the F1 button to select [Display]. Notice 'Display' appears on the display and a new sub menu appears.  
  
To print the loop map  
Press the F2 button to select [Print]. Notice 'Print' appears on the display.
- c) Press the F4 button once to select <etc>.
- d) Press the F3 button to select [UserCode]. Notice a message on the display 'Enter access code' followed by a flashing cursor.
- e) Use the full keyboard to input your access code and then press Enter button.
- f) Press the F4 button to select <etc>.
- g) Press the F2 button to select [Map] at the control panel.
- h) Press the F2 button to select [Net Map] and then press the F2 button to select [Enter].

Notice a network map with panel numbers are either printed or displayed.

This page has been intentionally left blank.



---

# Site Labels Information

## Site Labels

This section is for insertion of site specific labels and configuration details. A printout from the computer should be kept here for future reference.

The information in this section should be updated whenever there is a change to the site label or configuration.



This page has been intentionally left blank.



---

# Log Book Sheets

## Logging Events

A Log Book is provided with the Control panel and Repeat panel. It is provided to record events such as Fires, Faults and Warnings in the System 34000 fire detection and alarm system.

The Log Book is used by responsible persons and suitably qualified and trained Maintenance Engineers to log any events and information of any work carried out on the system for future reference.

The cover sheet of the log book is filled in after the commissioning of the System and provides useful information such as names and telephone numbers to contact in an emergency.

## Blank Log Sheets

Blank Log Sheet are included in this section which may be copied whenever the current sheet in the Log Book becomes full.

## Completed Log Sheet

A completed log sheet may be hole punched and kept in this section for future reference.



---

This page has been intentionally left blank.





This page has been intentionally left blank.



This page has been intentionally left blank.

# INDEX

## A

Aux Relays . . . . . 5-26

## B

### Battery

lead acid . . . . . 1-2

lithium . . . . . 1-2

BS5839 . . . . . 1-1

## C

Card . . . . . 5-27

### Control Panel

LCD display . . . . . 2-1

lights . . . . . 2-1

## E

Edit Labels . . . . . 5-17

Equipment . . . . . 2-1

## F

Fault buzzer . . . . . 4-4, 4-7

Fire Buzzer . . . . . 4-2

Function keys . . . . . 5-1

## K

Keyboard . . . . . 2-1

## L

### Lights

Fault . . . . . 4-4

fire . . . . . 4-3

power . . . . . 2-2

Warning . . . . . 4-7

Log Book . . . . . 4-3, 4-5, 4-8

### Logs

fault . . . . . 5-7

fire . . . . . 5-6

historic . . . . . 1-1, 5-9

warning . . . . . 5-8

## M

Manual call point . . . . . 1-2

Master Alarms . . . . . 3-3, 4-10

### Menu Options

[Aux Rly] . . . . . 5-26

[Disable] . . . . . 5-22

[Disp test] . . . . . 3-3, 5-2

[Enable] . . . . . 5-22

[Fault] . . . . . 4-5

[Loop Map] . . . . . 5-28

[Paper Fd] . . . . . 5-15

[Save] . . . . . 5-21

[Set Clock] . . . . . 5-4

[Test] . . . . . 5-15

[UserCode] . . . . . 5-14

{Params} . . . . . 5-1

## P

Panel Healthy . . . . . 2-2

Paper roll . . . . . 1-4

Password . . . . . 5-14

Printer . . . . . 5-15

## S

Sector Alarms . . . . . 3-4, 4-10, 4-11, 4-12

Silence Alarms . . . . . 3-3, 4-9

Sound Alarms . . . . . 3-3, 4-9

## V

View labels . . . . . 5-19

This page has been intentionally left blank.



# System 34000 system parts

## Introduction

This section lists parts used in the System 34000 system. For further details on the availability of the parts, contact GENT.

## Control and indicating equipment

\* - First fix products

# - Not available at the time of issue

Control Panels	34K-1ST-FIX*	Control panel backbox + Battery box
	34K1-V3+	Control panel (V3+) c/w 1 loop card
	34K1-LB-V3+	Control panel (V3+) c/w 1 loop card (less batteries)

**NOTE:** The Control Panel is supplied as **two** parts, ie 34K-1ST-FIX and 34K1-V3+.

Control panel accessories	34K-FLUSH	Control panel flush surround
	34K-19-RACK	Control panel 19" Rack mounting bracket
Terminal Node	34K-NODE-V3+	Terminal Node
	34K-NODE-LB-V3+	Terminal Node (less batteries)
Repeat panel	34K-RPT-1ST-FIX	Repeat Panel Backbox
	34K-RPT-V3+	Repeat panel (V3+)
	34K-RPT-LB-V3+	Repeat Panel (less battery)
	34K-RPT-FLUSH	Repeat Panel Flush Surround

**NOTE:** The Repeat Panel is supplied as **two** parts, ie 34K-RPT-1ST-FIX and 34K-RPT.

Mimic panels	34K-MIM	Mimic panel c/w drawing
	34K-MIM-LB	Mimic panel c/w drawing (less battery)
	34K-ZONE	Zonal mimic panel
	34K-ZONE-LB	Zonal mimic panel (less battery)

	34K-MIM-A4	A4 Mimic Panel
	34K-MIM-A4-LB	A4 Mimic Panel (less battery)
	34K-ZONE-A4	A4 Zonal Mimic Panel
	34K-ZONE-A4-LB	A4 Zonal Mimic Panel (less battery)
<b>Spares</b>	34K-BATT	Spare control panel battery box
	34K-BATT-RPT	Spare repeat/mimic panel battery pack
	34K-PAPER	Spare printer roll Mtp 401
<b>Extra cards</b>	34K-LCC-V3+	Local controller card
	34K-LCC-NOD-V3+	Local Controller Card for Terminal Node
	34K-LPC-V3+	Loop Card
	34K-RAM	RAM Card
	34K-NC-V3+	Network card
	34K-IOC-V3+	Input/Output card
	34K-IOC-SLV-V3+	Slave Input/Output Card (for Terminal Node)
	34K-IOC-DOM-V3+	Domain Bridge Input/Output Card
	34K-IOC-UNI-V3+	Universal Communications Input/Output card
	34K-IOC-UFD-V3+	Universal Communications Input/Output card Full Duplex
	34K-IOC-PRT-V3+	Remote printer input/output card

## Sensors and Accessories

<b>Sensors</b>	34710	Optical heat sensor
	19271-01	Optical chamber
	34710-RL	Optical heat sensor with Remote LED connection Remote LED
	34710-ML	Optical heat sensor with MCP connection (Chinese market only)
	34770	Optical heat sensor sounder
	19271-01	Optical chamber
	34780	Heat sounder
	19274-01	Heat sounder chamber

	34720	Heat sensor
	19272-01	Heat chamber
	34730	Ionisation sensor
	19273-01	Ionisation chamber
	34729	Environmentally protected Heat sensor
	34740	Beam sensor pair
	34741-01	Angle bracket with base
	34741-90	IP65 Angle bracket with base
	34741-03	Parallel bracket with base
	07012-31	Conventional Flame detector
	34760	Duct sensor (inc 17908-05 Probes & 34702 Slave LED unit)
<b>Tools</b>	17918-22	Sensor chamber Extractor cup
	17918-23	Optical chamber electronics module removal tool
	17918-24	Ionisation chamber electronics module removal tool
	17918-25	Heat sensor electronics module removal tool
	17918-26	Sensor removal tool kit
<b>Terminal Plate</b>	34700	3-way terminal plate
	34704	4-way terminal plate
	19279-01	Semi-flush sensor mounting kit
	07700-21	Base for Conventional flame detector
<b>T Breaker and Slaves</b>	34701	T breaker Unit
	34702	Slave LED unit
	34703	Slave Relay unit

## Alarm sounders

	34202	Sounder
	34203	Sounder T-Breaker
	34213	Environmentally protected Sounder T-Breaker
	34777	Repeat sounder (VIG-SEN-TERM required)

## Manual call points (MCP) 2-way

	34800	Surface mounted MCP
	34807	Surface mounted keyswitch MCP
	34842	Surface mounted MCP with cover
	34812	Surface mounted water resistant MCP
	19289-01	MCP flush fixing plate
	34852	Surface mounted water resistant MCP with cover
	34829	Environmentally protected surface mounted MCP
<b>Spares</b>	13480-09	Spare MCP glasses 10 pack for LPCB approved
	14112-09GR	Spare MCP glasses 10 pack non LPCB approved

## Interfaces

<b>Mains powered</b>	34440	Mains powered fire alarm interface
	19104-52	Power relay (for mains powered interface) (up to 4 maximum can be used - supplied with base and diode)
<b>4- Channel Loop powered</b>	34450	Loop powered fire alarm interface
	19245-05	Interface line module -up to 4 can be fitted in a loop powered fire alarm interface
	34454	4 way keyswitch door for loop powered interface
<b>1- Channel Loop powered</b>	34410	Loop powered zone module
	34415	Single Channel Interface (Loop Powered)
	19245-05	Interface line module
<b>Rack</b>	13445-80	Rack interface back box
	13445-05	Rack interface
	13445-06	Interface rack door
	13445-15	4 way interface line module assembly

<b>Keystitches</b>	19245-02	2 position keyswitch assembly (for use with optional interface doors)
	19245-03	3-position keyswitch assembly (for use with optional interface doors)
	13445-40	Interface card (loop powered) (up to 10 used in 13445-05 rack interface)
<b>Power supply Unit</b>	19245-06	Power supply unit with 1 relay (for use with loop powered interface unit)
	19245-07	Mains relay (up to 4 for use with 19245-06 unit)
<b>Fix Extinguishant</b>	34460	Loop powered fixed extinguishant interface

## Manuals & Accessories

34K-MAN-INS	System 34000 Installation manual
34K-MAN-OPS-V3+	System 34000 Operator's Manual
13563-011	GENT Supervisor Operator's Manual

## GENT Supervisor

13563-10	Supervisor Text computer
13563-11	Supervisor Graphic II computer

**NOTE:** *The Gent Supervisor graphics software requires custom graphics pages*

<b>Text software</b>	13565-01	Supervisor Information mode software
	13565-04	Supervisor Configuration mode software
<b>Graphics software</b>	13566-05	Supervisor Text (information)/Graphics II software
	13566-06	Supervisor Text (Configuration)/Graphics II software
	13563-09	Supervisor Text/Graphics II software Upgrade
<b>Accessories</b>	13563-03	Supervisor Text Printer
	13563-04	Supervisor Graphics Printer
	13563-05	Supervisor Light pen

4214-006	Fan fold paper (for 13563-03)
4214-054	A4 paper 5 reams (for 13563-04)

## Converter / Compactor / UPS / Printer

13547-14	Uninterrupted power supply (70 minutes standby)
13547-15	Uninterrupted power supply (55 minutes standby)
13563-02	Supervisor Converter/Splitter unit (RS232/RS485)
13548-03	RS232 Compactor unit (1 to 8 - RS232)
13562-01	Remote printer
13563-01	Supervisor Modem (pairs)